

ENN01-SKSD7-F1 (CCT 2700K)

1. Product Name HYPERSUNLIGHT

2. Luminous Element GaN

3. Application Lighting

4. Absolute Maximum Ratings (Ta=25°C)

Item	Symbol	Value	Unit
Power Dissipation	P_D	300	mW
DC Forward Current	I_F	100	mA
Pulse Forward Current (*1)	I_{FP}	130	mA
Allowable Reverse Current	I_R	60	mA
Operating Temperature	T_{opr}	0 ~ +100	°C
Storage Temperature	T_{stg}	-40 ~ +100	°C
Junction Temperature	T_j	120	°C

(*1) Duty 1/10, Pulse Width 10msec.

Allowed area to operate: I_F - T_s

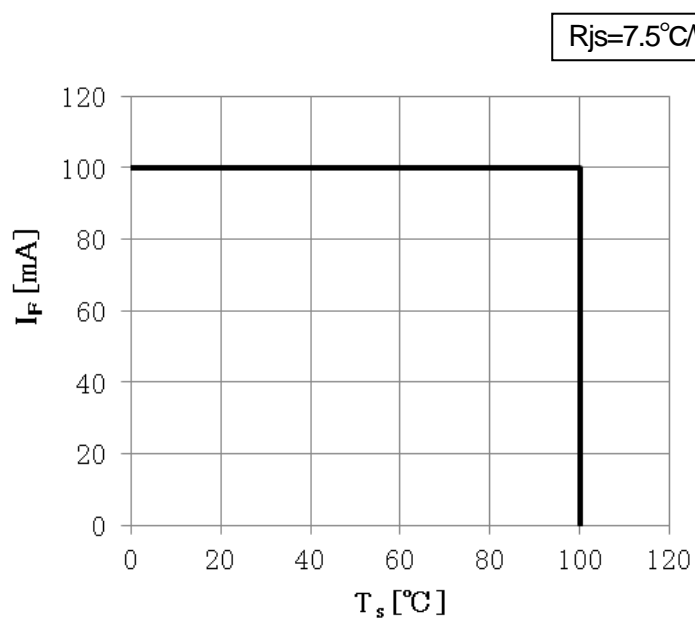

ENN01-SKSD7-F1 (CCT 2700K)

5. Electrical/Optical Characteristics (T_a=25°C)

Item	Symbol	Test Condition	Min.	Typ.	Max.	Unit
Forward Voltage (*2)	V _F	I _F =65mA	2.7	(2.93)	3.1	V
Luminous Flux (*3)	Φ _V	I _F =65mA	16.0	(18.9)	26.0	lm
Chromaticity (*4)	x	I _F =65mA	—	0.4578	—	—
	y		—	0.4101	—	
CRI (*5)	R _a	I _F =65mA	95	-	-	—
	R _{1~15}		90	-	-	—
Thermal Resistance	R _{j-s}	-	-	7.5	15	°C/W

Following Forward Voltage Ranking is applied. (I_F =65mA, T_a =25°C)

Rank	Forward voltage (V)
1	2.7 ~ 2.8
2	2.8 ~ 2.9
3	2.9 ~ 3.0
4	3.0 ~ 3.1

(*2) Forward Voltage measurement tolerance is ±3%

Following Luminous Flux Ranking is applied. (I_F =65mA, T_a =25°C)

Rank	Luminous Flux (lm)
M	16.0 ~ 18.5
N	18.5 ~ 21.0
P	21.0 ~ 23.5
Q	23.5 ~ 26.0

(*3) Luminous Intensity Measurement tolerance is ± 5%.

ENN01-SKSD7-F1 (CCT 2700K)

Following Chromaticity Ranking is applied. ($I_F=65\text{mA}$, $T_a=25^\circ\text{C}$)

Rank	K1,K2,K3,K4	K5,K6,K7,K8
Color Space	MacAdam 3-step	MacAdam 5-step
Center Point	$x=0.4578$, $y=0.4101$	
Major-axis Length a	0.009643	0.016072
Minor-axis Length b	0.004156	0.006927
Orientation θ°	26.90	

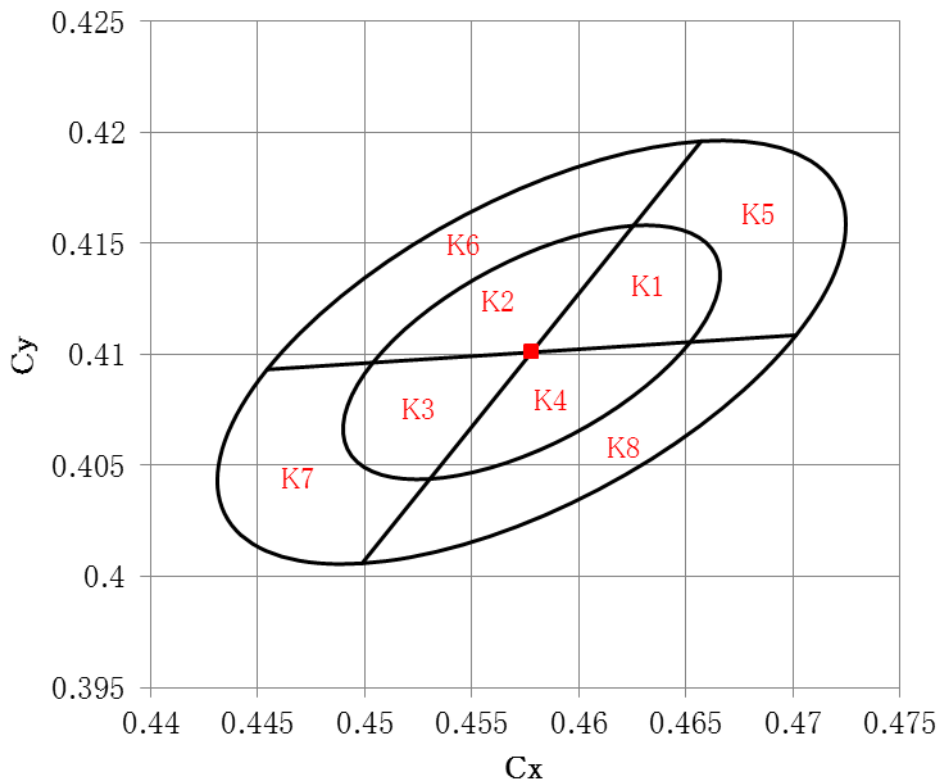

(*4) Color Coordinates measurement tolerance is ± 0.005 .

(*5) Color Rendering Index Ra, R1~R15 except for R9 tolerance is ± 2 , R9 tolerance is ± 4

(*6) The property value is at the time of the shipment, and the property value changes at time.

ENN01-SKSD7-F1 (CCT 2700K)

6. Part Number Formation

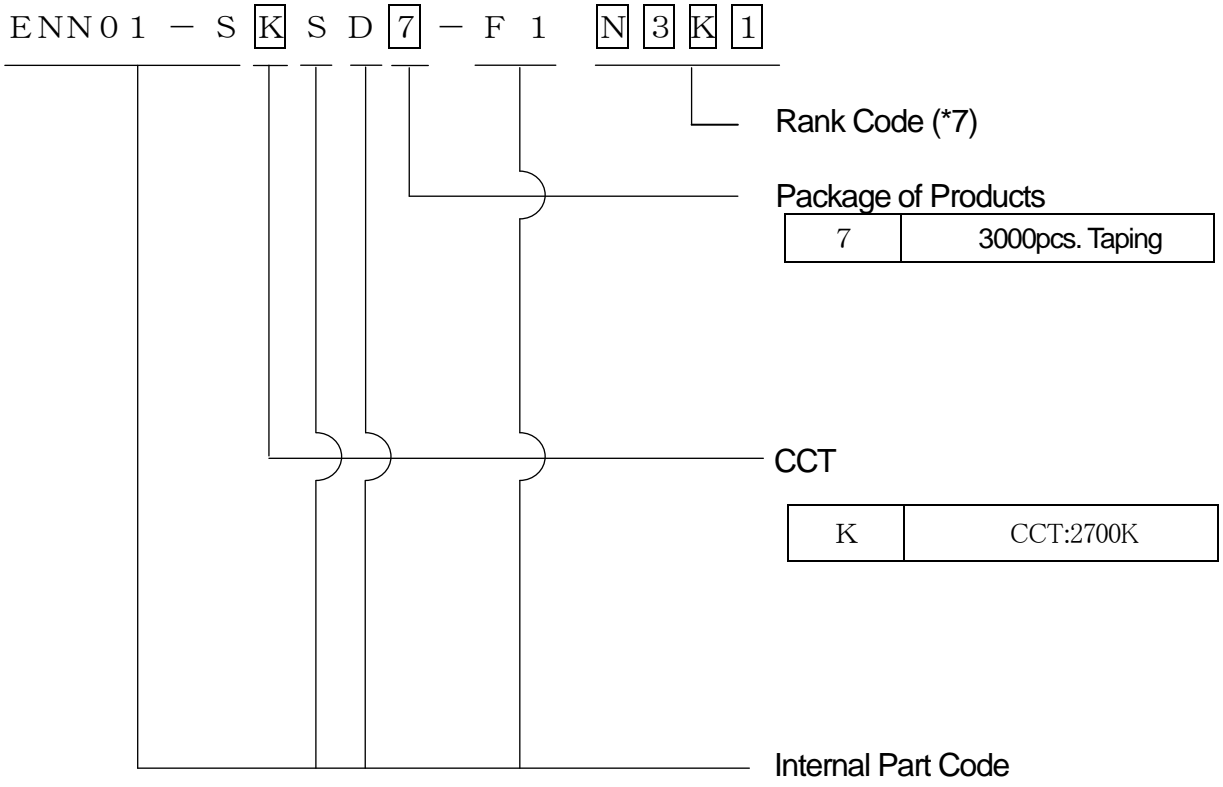

(*7) Rank Code

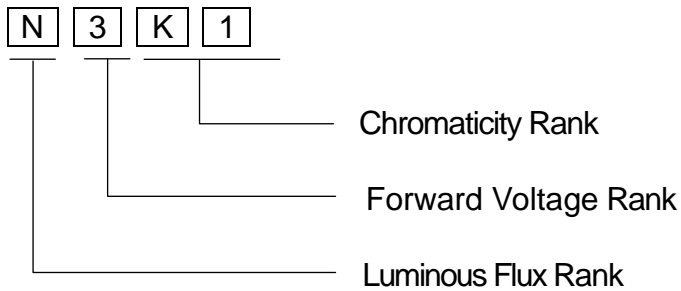

ENN01-SKSD7-F1 (CCT 2700K)

7. Outline Dimensions

Unit: mm

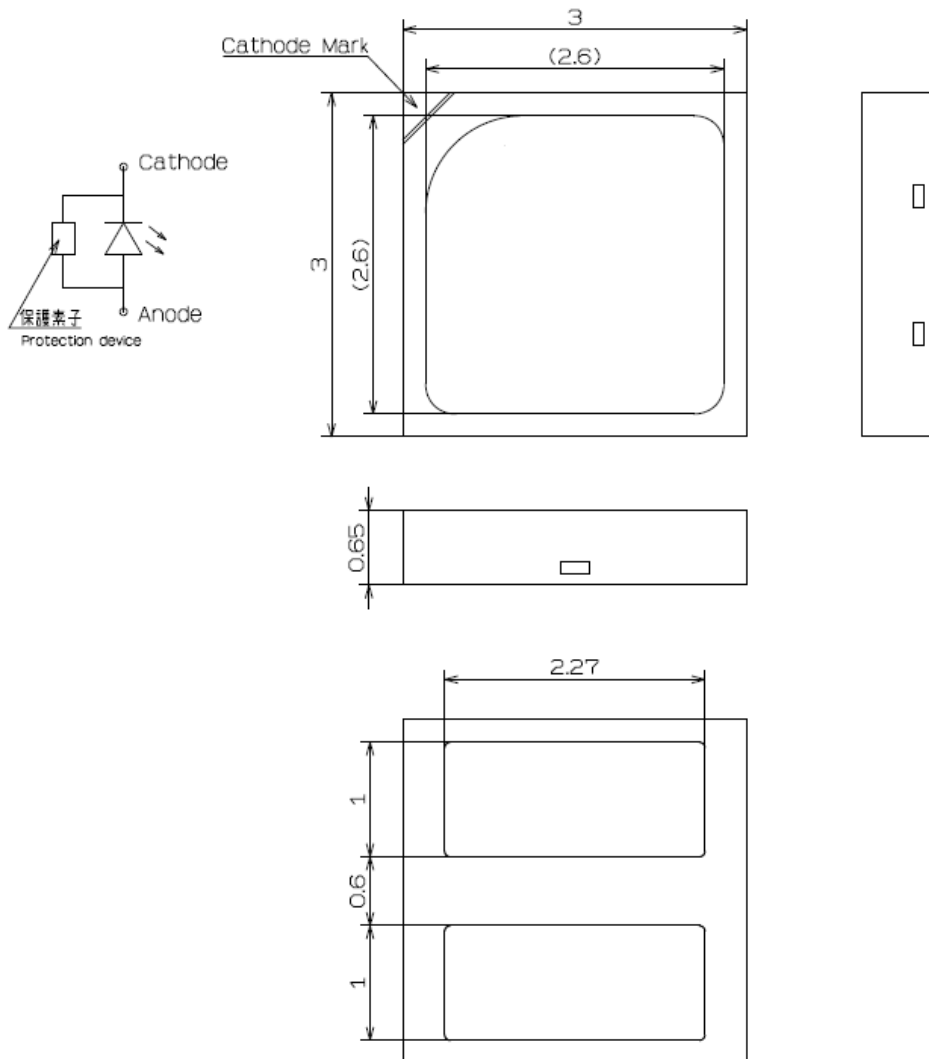

Item	Material
Package	Heat-Resistant polymer
Encapsulating resin	Silicone resin + phosphor
Lead frame	Cu Alloy + Ag Plating

(*8) The size of the product doesn't contain burr, etc.

(*9) General tolerance : ±0.2mm

ENN01-SKSD7-F1 (CCT 2700K)

8. Results of Reliability Test

Test Item	Standard Test Method (*10) JEITA ED-4701	Test Condition	Results
Operating Test	—	Ta=25°C、IF=65mA、t=1000h	0/10
High Temp. Operating Test	—	Ta=85°C、IF=65mA、t=1000h	0/10
High Humidity Operating Test	—	Ta=60°C、RH=90%、IF=65mA、t=1000h	0/10
High Temperature Storage Test	200 201	Ta=100°C、t=1000h	0/10
Low Temperature Storage Test	200 202	Ta=−40°C、t=1000h	0/10
High Humidity Storage Test	100 103	Ta=60°C、RH=90%、t=1000h	0/10
Temperature Cycle Test	100 105	Ta=(−40°C、30min. ~25°C、5min. ~100°C、30min.)×100cyc.	0/10
Temperature and Humidity Cycle Test	200 203	Ta=(−10°C~65°C)、RH=(90~96%)×10 cyc. 24h/cyc.	0/10
Resistance to Soldering Heat (Reflow Soldering)	300 301	T _{sd} =260°C、10sec、2 times	0/10
Electrostatic Discharges	300 304	1. 5kΩ、100pF、±2kV、3 times	0/10

(*10)Number : JEITA ("Japan Electronics and Information Technology Industries Association") standard methods are used.

Criteria for Judging the Damage

Item	Symbol	Test Condition	Limit	
			Min.	Max.
Forward Voltage	V _F	I _F =65 mA	—	Initial Value ×1.1
Luminous Flux	Φ _v	I _F =65 mA	Initial Value ×0.7	—

ENN01-SKSD7-F1 (CCT 2700K)

9. Typical Characteristics

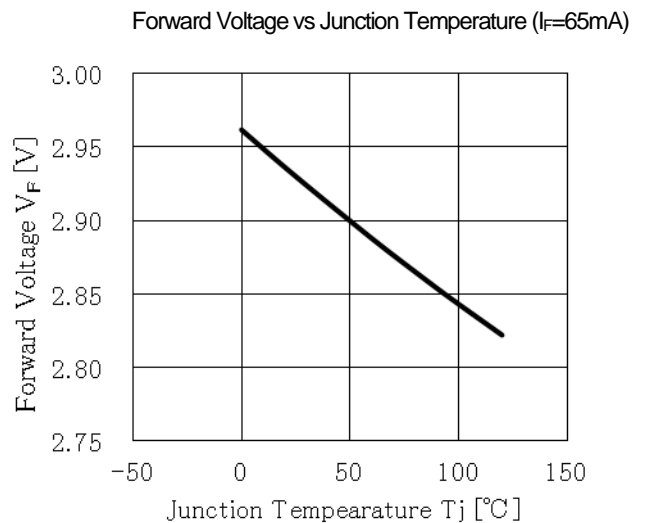
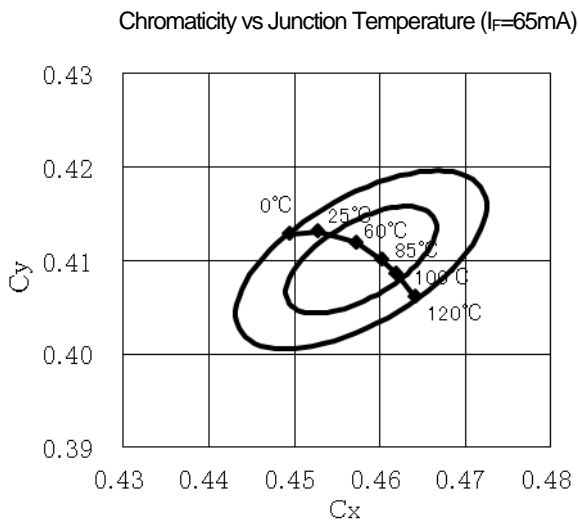
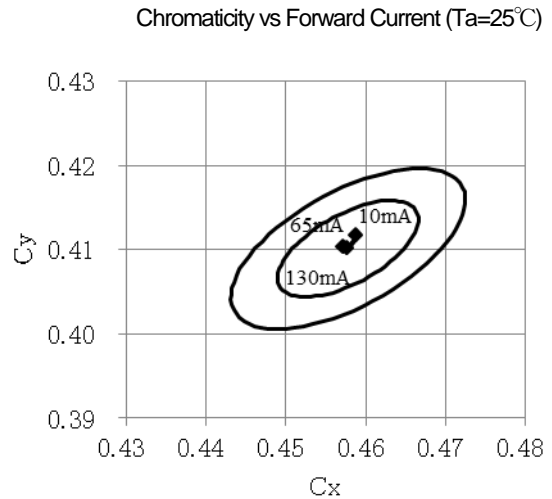
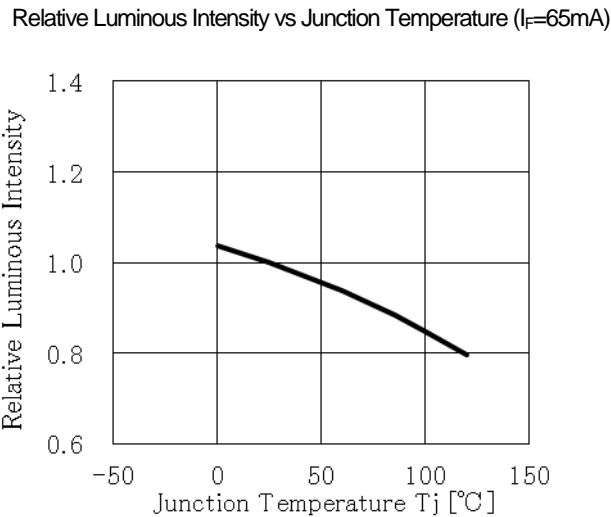
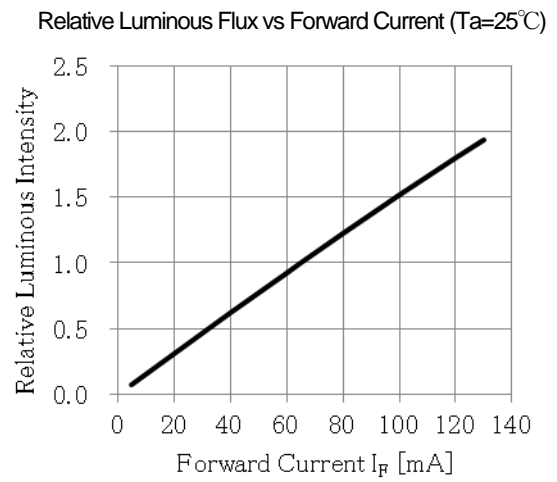
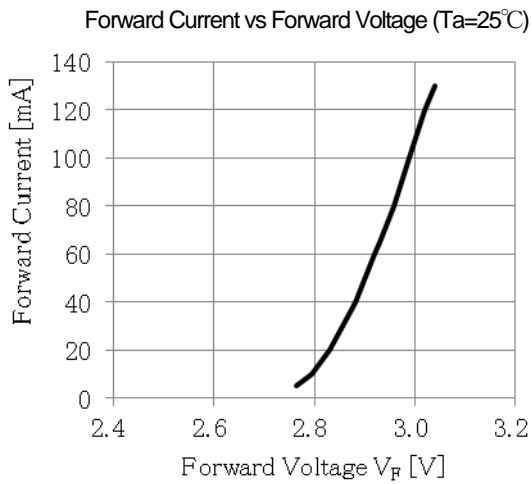

(*11)The data shown above are examples and are not guaranteed.

ENN01-SKSD7-F1 (CCT 2700K)

Spectrum (Ta=25°C, I_f=65mA)

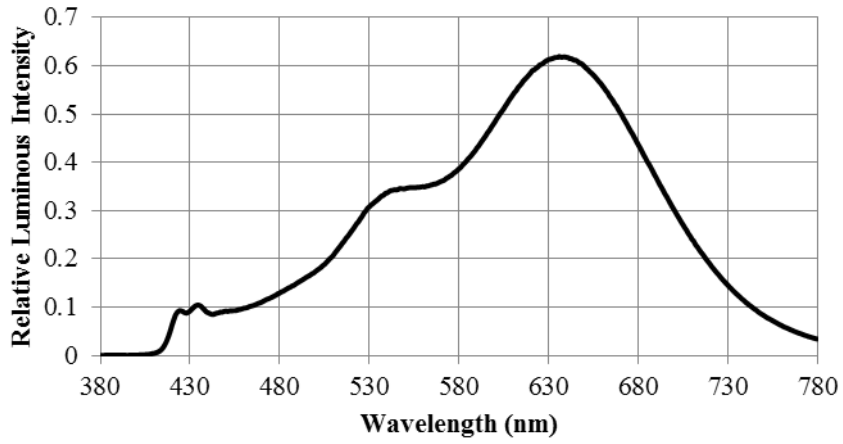

Radiant Pattern

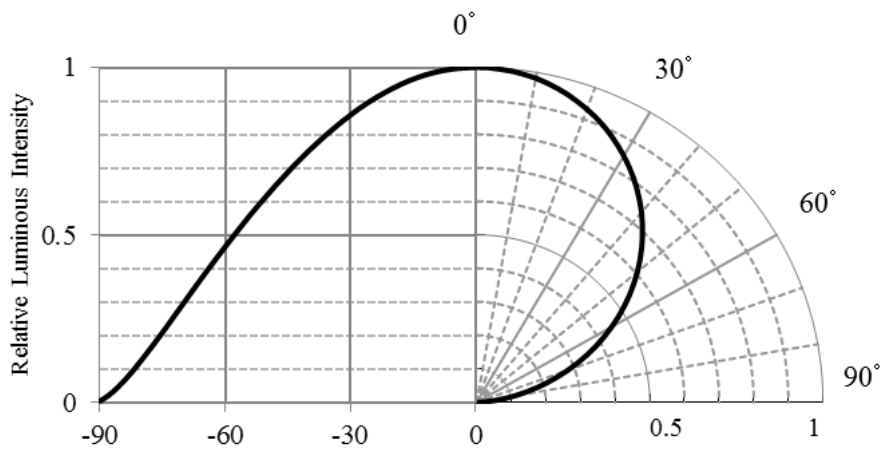

(*11)The data shown above are examples and are not guaranteed.

ENN01-SKSD7-F1 (CCT 2700K)

10. Shipping Package Style

(1) Package

3000 pieces are packed in ESD protected bag. This product puts one 3000 pieces/reel in the dampproof packing, and displays the Product Name, Product Number, Lot No., Rank, and Quantity outside of the bag.

Bag: dampproof package made of aluminum

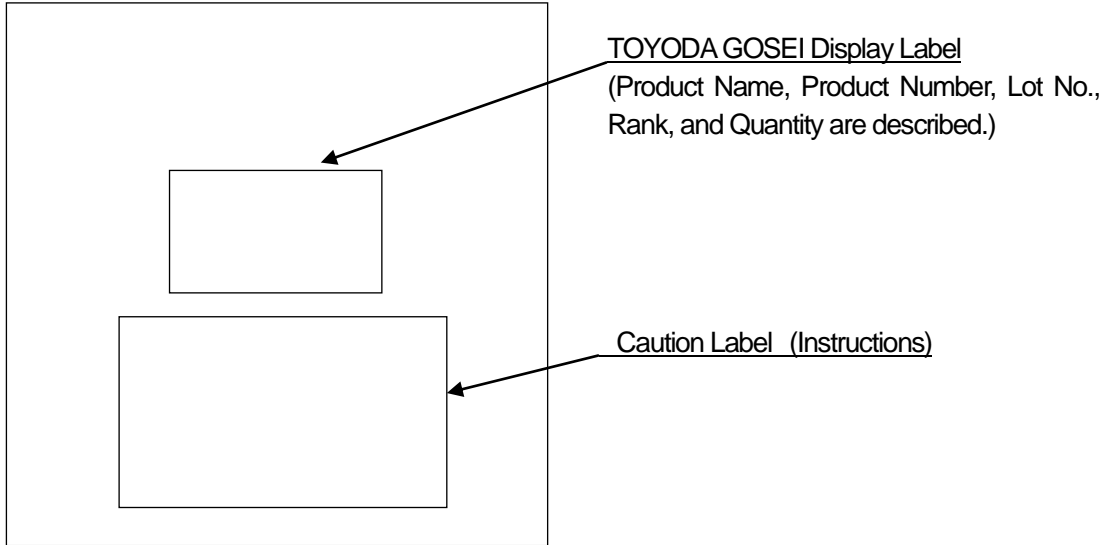

For this product, the dampproof bag mentioned above contains one reel, and is put in a packing box

ENN01-SKSD7-F1 (CCT 2700K)

(2) Label Formation

TOYODA GOSEI Display Label: Product Name, Product Number, Lot No., Rank, and Quantity are displayed as follows.

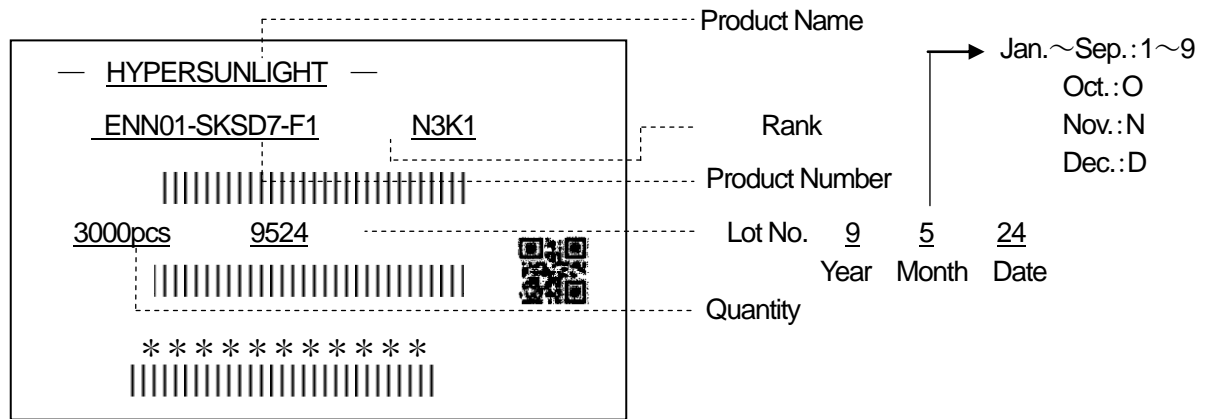

(3) Tape Dimensions

Unit:mm

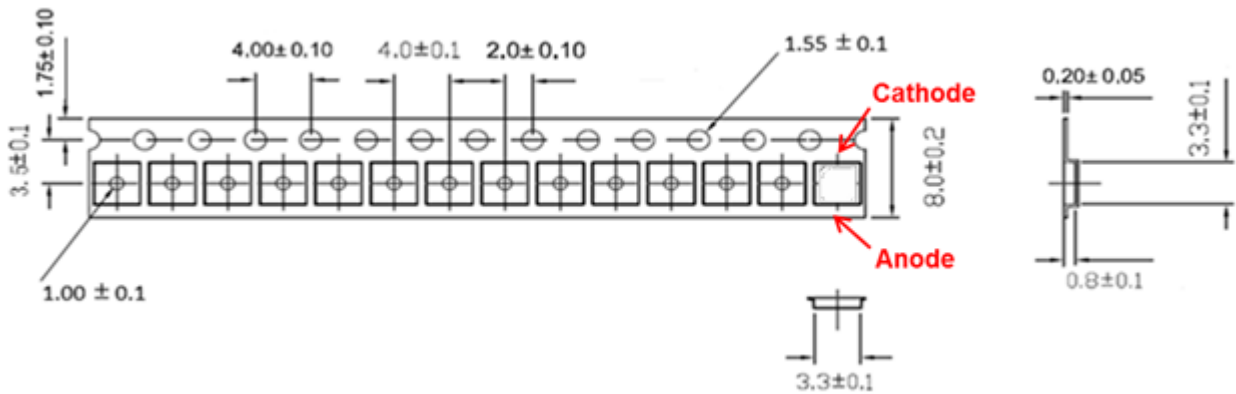

(*12) The cumulative pitch deviation is assumed to be ± 0.2 mm or less for ten pitches.

ENN01-SKSD7-F1 (CCT 2700K)

(4) Reel Dimensions

Unit: mm

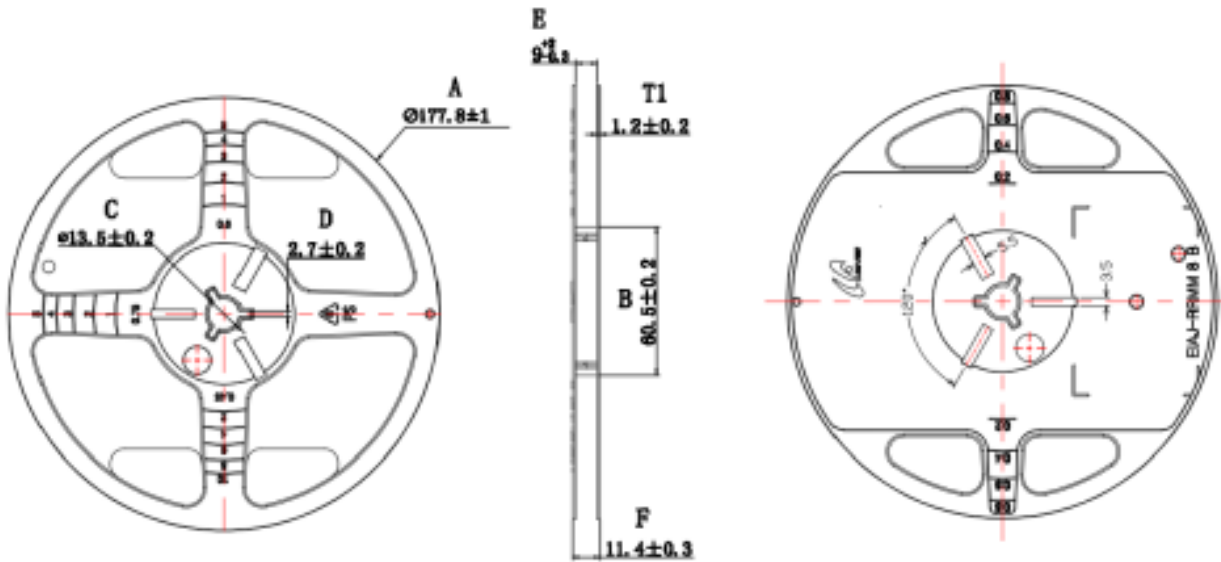

11. PRECAUTIONS IN HANDLING

(1) Safety Precautions

Do not look directly at the LED with unshielded eyes, or damage to the retina may result.

(2) Static Electricity

- These products are sensitive to static electricity, and a high standard of care must be taken. Particularly if an over-current and over-voltage that exceeds the Absolute Maximum Rating of Products is applied, the overflow in energy may cause damage to, or possibly result in destruction of, the Products. Customer shall take absolutely secure countermeasures against static electricity and surge when handling Products.
- A protection device should be installed in the LED driving circuit, which does not exceed the max. rating for surge current during on/off switching.
- Proper grounding of Products (via 1 MΩ), use of conductive mat, semi conductive working uniform and shoes, and semi conductive containers are considered to be effective as countermeasures against static electricity and surge.
- A soldering iron with a grounded tip is recommended. An ionizer should also be installed where risk of static generation is high.
- If the countermeasures mentioned above are implemented, LED can work well. Users are required to confirm those countermeasures when problems are caused by static electricity.

(3) Attention in drive

Please use this product by the forward voltage. The element might be damaged by the migration in the drive to which a reverse-voltage hangs and avoid it, please.

(4) Attention in the product handling

- This product uses silicone as the encapsulating resin, therefore there may be influence on its characteristics or reliability depending on the handling and use environment.
- Products which use silicone encapsulation resin, which is soft, may be adversely affected by stress which may cause cracking or delamination. Please ensure that excessive stress is not used when handling.
- For example, when using an automatic mounting machine, please use a vacuum nozzle that does not put the stress on the encapsulating resin when you use the automatic mounting machine.
- Please do not put stress on the encapsulating resin with a sharp treatment device, such as tweezers.
- The tuck of the silicone resin is stronger than that of epoxy resin. Please note that there is danger that an optical characteristic changes by the adhesions of the foreign body and dust, etc. Please note that there is danger that interferes to reliability.

(5) Soldering Condition

When soldering chip LEDs, it is likely that the humidity within the resin may disturb the adherence of junction. The optical characteristics and reliability of devices may be adversely affected, and may result in no emitted light by disturbance.

- Please do not put the stress on the resin in the state of the high temperature

ENN01-SKSD7-F1 (CCT 2700K)

- The product must not come in contact with other materials when the substrate mounting and it transports it.
- Please go for the reflow solder within the range of recommended reflow temperature profile of next page description.
- The reflow solder is made twice, and the keeping condition from the 1st time of the reflow solder to the 2nd times of the reflow solder is given to me as 30°C/60%RH×168h or less.
- Do not mount by flow-soldering.
- Please go for 5 seconds at 300°C or less by one time at the correction with the hand solder.

<Recommended Soldering Pattern>

The following dimension does not guarantee the performance for mounting the product.
Please adopt it after confirming it beforehand.

Unit: mm

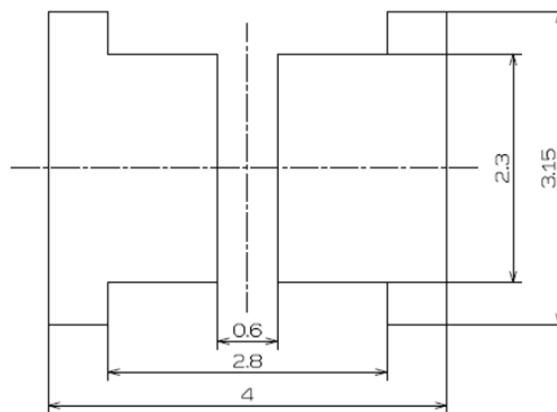

<Reflow Soldering Profile>

The following profile does not guarantee the performance for mounting the product.
Please adopt it after confirming it beforehand.

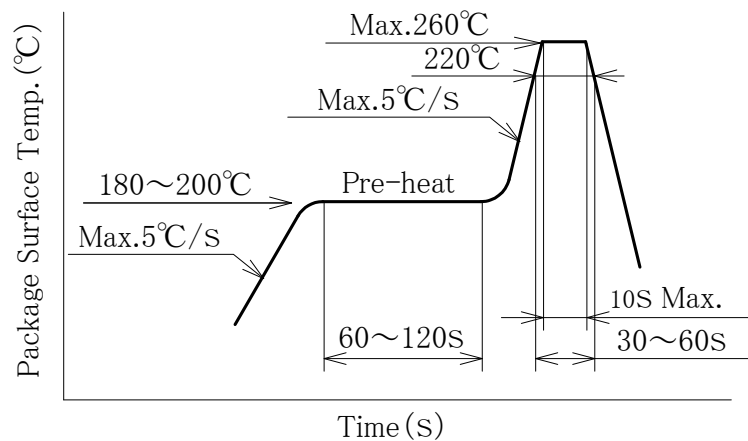

ENN01-SKSD7-F1 (CCT 2700K)

(6) About the atmosphere used

The characteristics of this product may be adversely affected when it is exposed in atmospheres such as the corrosion gas. When it is used with the following atmosphere, please perform adequate reliability tests.

- Dew (moisture), salt water, corrosion gas (S element content gases such as SO_x and H₂S, Cl element content gases, and NO_x and NH₃, etc.), etc.
- Organic solvent, oil, drug solution such as acid / the alkali
- Direct sunshine, out-of-door exposure, in dust, etc.

(7) Packaging

These LED devices are packed in an aluminum envelope with a silica gel and a moisture indicator to avoid moisture absorption. The optical characteristics and reliability of the devices may be adversely affected, and may result in no emitted light by exposure to moisture in the air before soldering and they should therefore be stored under the following conditions:

1. This moisture proof bag may be stored unopened within 12 months at the following conditions
Temperature : 5~30°C
Humidity: 90 % (MAX)
2. After opening the moisture proof bag, the devices should be assembled within 168 hours in an environment of 5°C to 30°C/60%RH or below.
3. If the LEDs have exceeded above storage condition, the devices should be baked in taping with reel. After baking, use the baked devices within 168 hours, but perform baking only once.
Baking conditions : 60±5°C, for 24 to 48 hours.
4. Repeated baking can cause the peeling strength of the taping to change, then leads to trouble in mounting. Furthermore, prevent the devices from being destructed against static electricity for baking of it.
5. If the packing of aluminum envelope would be broken, the hermeticity would deteriorate. Therefore, do not throw or drop the packed devices. Indicator in moisture proof bag functions hygrometer, it does not indicate condition of moisture absorbed.
6. In the electrode part of this product, the plating is taken, and the plating surface changes in quality when exposed to an atmosphere that includes causticity gas, and what a problem produces at the time of soldering is thought about. Please be careful to the management of the safekeeping atmosphere enough.

(8) Cleaning

- If cleaning of the LED becomes necessary after mounting on a board, use Isopropyl alcohol for cleaning. Prior to the actual cleaning, confirm that the cleaning process causes no problem, as the cleaning process is known to cause expansion of the encapsulation-resin, depending on the cleaning conditions. Also, do not use chorine-based solvents, as they will cause corrosion of the lead frame, dissolve the resin, and/or cause degradation of the device.
- Regarding ultra-sonic cleaning, confirm that the cleaning process causes no problem on the LED under operating conditions
- Do not brush-clean the LED, as it will damage the light-emitting area of the device.
- When drying is not enough in using water for washing or a rinse, it can cause the deterioration of the product. Please completely remove the water by drying.

ENN01-SKSD7-F1 (CCT 2700K)

12. WARRANTY

- (1) Manufacturer only warrants that the Products will conform to the items and conditions described in paragraphs 4,5,6,7 and 10 in these Specifications.
- (2) Absolute maximum ratings shown on paragraphs 4 represent a limit to prevent the product from immediate degradation or break. These values are not a guarantee of lumen maintenance, which is generally a function of junction temperature and environmental conditions.
- (3) Manufacturer's warranty as set forth in 12(1) above applies only when each Product stands alone. In no event shall Manufacturer assume responsibility for failure of injury arising out of Customer's installation or assembly of Products into Customer's equipment.
- (4) Customer shall conduct its receiving inspection of the Products promptly upon delivery, and in the event any Products in the respective delivery are found not to conform to any of Manufacturer's warranties, Customer may reject and shall return such non-conforming Products to Manufacturer for replacement. Customer shall provide the reason and the number for such rejection with the return of each non-conforming Product.
- (5) MANUFACTURER MAKES NO OTHER REPRESENTATION OR WARRANTIES, EITHER EXPRESS OR IMPLIED, CONCERNING THE PRODUCTS, INCLUDING, WITHOUT LIMITATION, WARRANTIES OF MERCHANTABILITY OR FITNESS FOR A PARTICULAR PURPOSE.
- (6) Manufacturer's liability for nonconforming Products shall be in any case limited to replacements of nonconforming Products, provided that such nonconformity is attributable to Manufacturer. In no event shall Manufacturer be liable for any costs or expenses incurred for replacement of such nonconforming Products, consequential damages or lost profits.
- (7) The period of the warranty for the Products by Manufacture shall be twelve (12) months from the date the Products are delivered to the Customer. Notwithstanding the foregoing, the warranty shall not apply to any of the following, even during such warranty period:
 - (a) Failure of, or injury caused by the Products due to mishandling or misuse of the Products by Customer;
 - (b) Failure of, or injury caused by the Products due to inappropriate repair or modification by Customer;
 - (c) Failure of, or injury caused by Products due to force measure including, without limitation, fire, earthquake, flood, lightning or other natural disasters, or pollution, damage from briny air or outbreak of a state of emergency; or
 - (d) Any failure and damage caused by not following the handling precautions listed in Section 11 of these Specifications.
- (8) The warranty provide for in these Specifications constitutes the entire and only agreement between Customer and Manufacturer with respect to the quality of the Products and supersedes, cancels and annuls all prior or contemporaneous negotiations or communications whether written or oral.

ENN01-SKSD7-F1 (CCT 2700K)

- (9) Customer, on its own responsibility, shall check and confirm the reliability and quality of the Products under (1) conditions in which the Products are installed or incorporated in the application ("Application"), (2) actual conditions in which the Products and/or the Application are used and (3) other conditions which are not provided in these Specifications.
- (10) The warranty provided for in these Specifications can only be modified by a written agreement signed by the representatives of both Customer and Manufacturer.
- (11) IN NO EVENT SHALL MANUFACTURER BE LIABLE TO BUYER FOR (I) ANY LOSS OR DAMAGE (WHETHER SPECIAL, CONSEQUENTIAL, COMPENSATORY, PUNITIVE, EXEMPLARY, DIRECT, INDIRECT OR OTHERWISE) TO CUSTOMER'S PROPERTY RESULTING FROM THE USE, HANDLING, TRANSPORTATION, SALE, STORAGE, REPAIR, MODIFICATION OR MAINTENANCE OF THE PRODUCTS, WHETHER IN THE MANUFACTURING OR INSTALLATION PROCESS, ALONE, IN COMBINATION WITH OTHER GOODS, MATERIALS, EQUIPMENT OR SUBSTANCES OR OTHERWISE, (II) ANY LOSS OF USE, REVENUE OR PROFIT OR DIMINUTION OF GOODWILL, EVEN IF MANUFACTURER KNEW OR SHOULD HAVE KNOWN OF THE POSSIBILITY OF SUCH LOSS, DAMAGE OR DIMINUTION, (III) ANY INJURY TO OR DEATH OF PERSONS AND (IV) ANY CLAIM, DEMAND, ACTION, LAWSUIT OR OTHER PROCEEDING AGAINST CUSTOMER BY ANY THIRD PARTY, WITH RESPECT TO (A) ANY LOSS OR DAMAGE (WHETHER SPECIAL, CONSEQUENTIAL, COMPENSATORY, PUNITIVE, EXEMPLARY, DIRECT, INDIRECT OR OTHERWISE) INCURRED, SUFFERED OR OTHERWISE CLAIMED BY SUCH THIRD PARTY OR (B) ANY INJURY TO OR DEATH OF PERSONS.

MISCELLANEOUS

- (1) No license or right, expressed or implied, shall be granted.
- (2) The Products described in these Specifications are intended only for standard applications or general electronic equipment such as office equipment, communications, electronic instrumentation and household electrical appliances.

When they are used for transport equipment, disaster prevention and crime prevention equipment as well as other safety devices calling for high reliability and safety, Customers are requested to pay particular heed to the safety design of the equipment as a whole in terms of fail-safe design and redundant design to maintain the reliability safety of such equipment.

Do not use them for special applications (and such as aviation, space craft and life-sustaining equipment) requiring exceptionally high reliability and safety, and if their failure or malfunction may threaten human lives or may detrimental to human bodies.

It is to be understood that the manufacturer shall not be held responsible for any damage incurred as a result of using the product for purpose which is not the standard the manufacturer has intended to be used for, unless the manufacturer articulate agrees to the no-standard use in writing.

- (3) Customers must comply with the laws and public regulations concerning safety.

ENN01-SKSD7-F1 (CCT 2700K)

The content of these Specifications shall be deemed fully accepted by Customer either (1) upon execution hereof by the Customer or (2) if Customer does not advise Manufacturer of any objections within two (2) weeks of the date of receipt of these Specifications, whichever is the earlier. If Customer does advise Manufacturer of any objections within two (2) weeks of the date of receipt of these Specifications, the parties shall negotiate an alternative acceptable to both parties, which alternative shall be deemed fully acceptable by Customer upon Customer's execution of the revised Specifications.

("Customer")

Date _____

Date _____

("Manufacture")

Date _____

- (4) If you have any questions regarding usable condition (drive condition, mounting) for TG LED products, please ask TG optoelectronics sales department in advance.